

PROFILE DO FOTOWOLTAIKI (szyny)

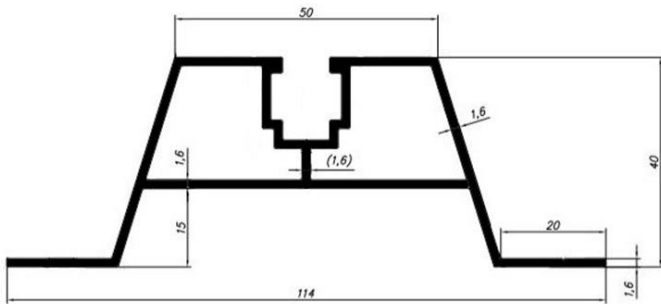

6148
1,201 kg/mb

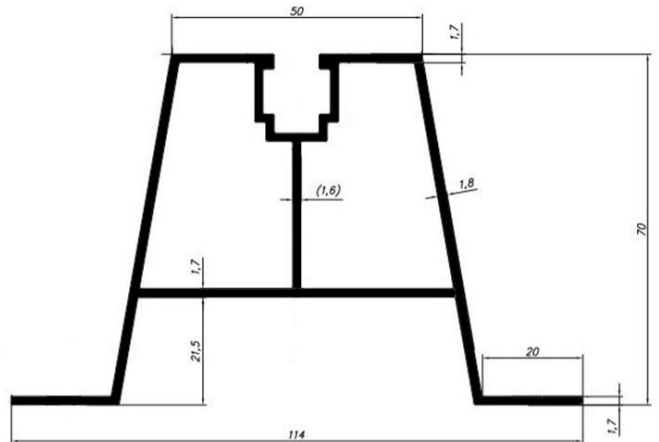

6149
1,671 kg/mb

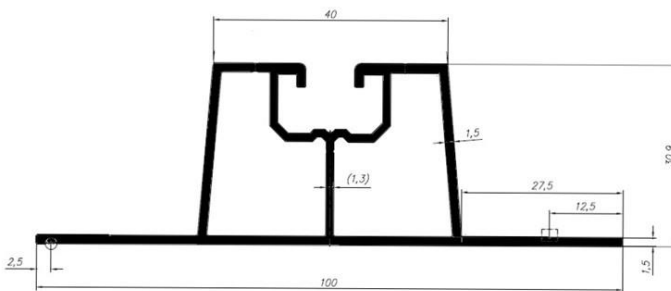

90444
0,983 kg/mb

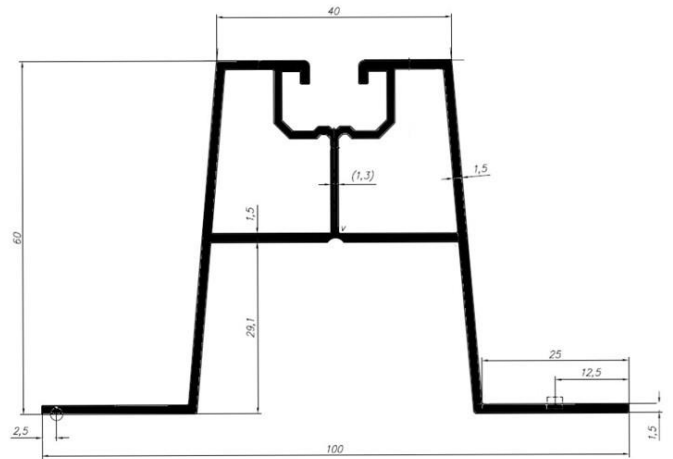

90445
1,199 kg/mb

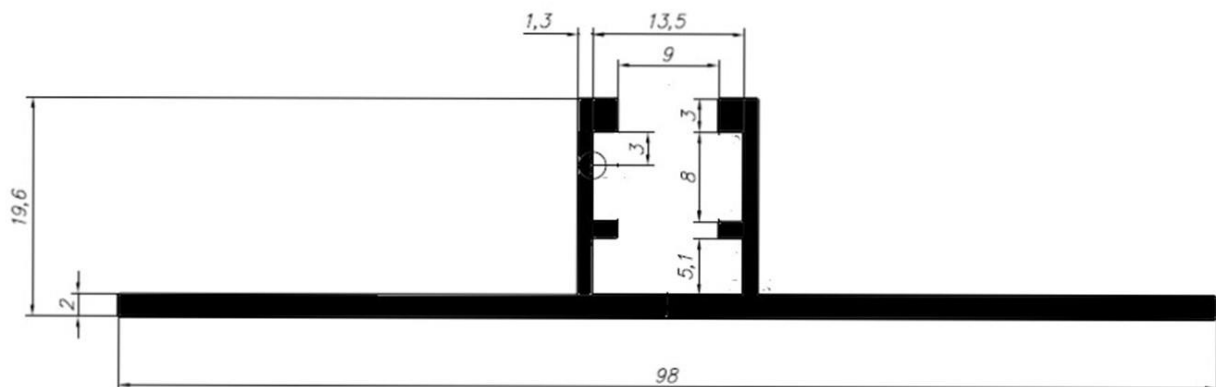

90454
0,707 kg/mb

PROFILE DO FOTOWOLTAIKI (szyny 2)

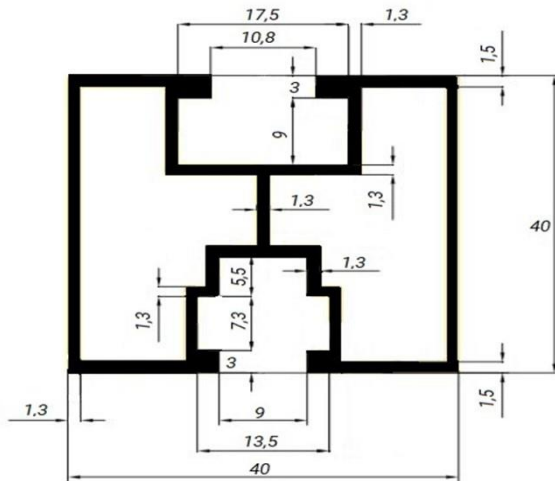

90337
0,886 kg/mb

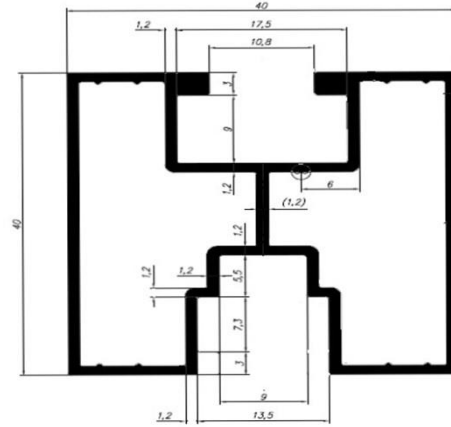

90435
0,806 kg/mb

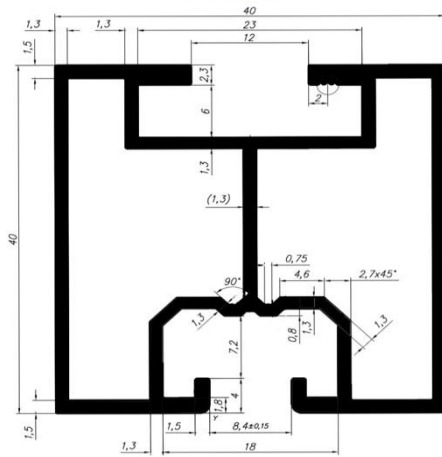

90440
0,888 kg/mb

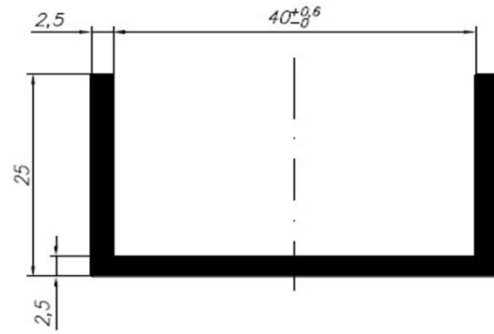

90431
0,607 kg/mb

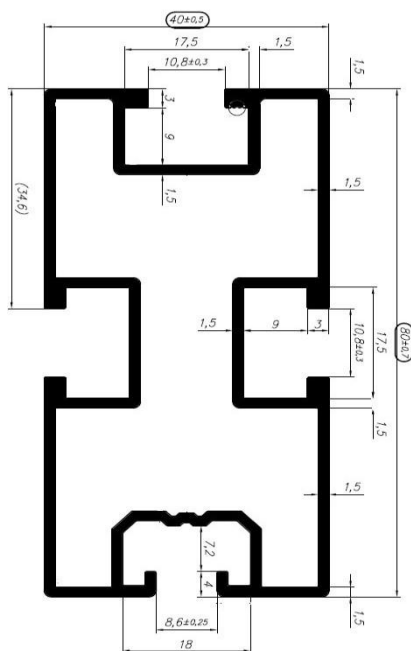

90443
1,55 kg/mb

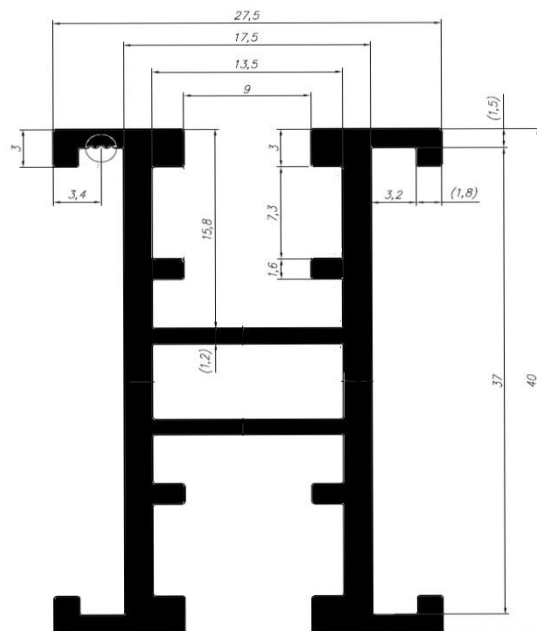

90453
0,741 kg/mb

PROFILE DO FOTOWOLTAIKI (klemy)

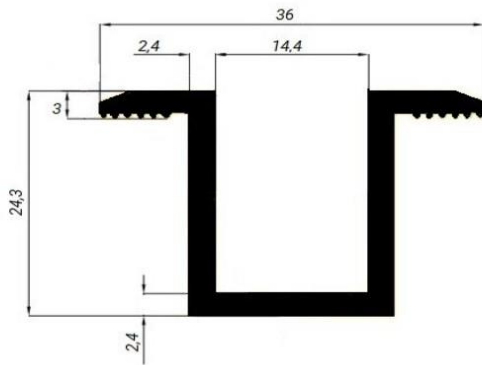

90338
0,519 kg/ mb

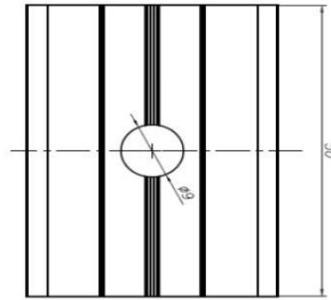

90338 (1)
0,519 kg/ mb

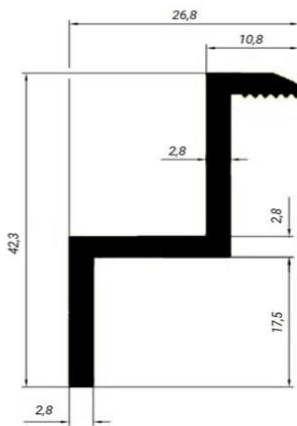
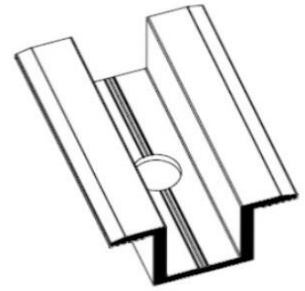

90339
0,50 kg/mb

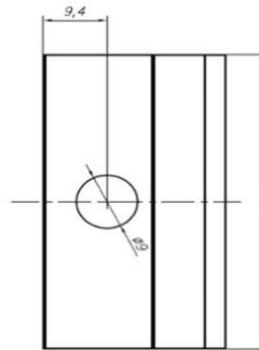

90339 (1)
0,50 kg/mb

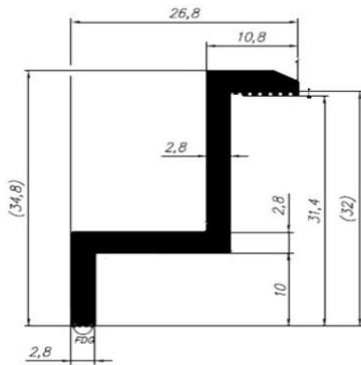
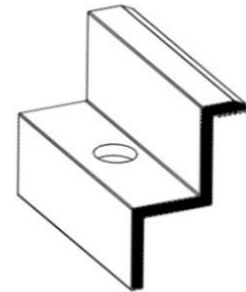

90432
0,444 kg/mb

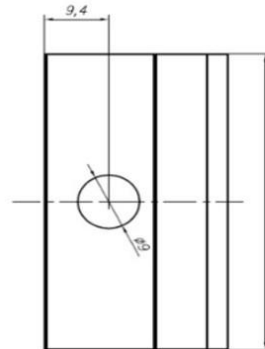

90432 (1)
0,444 kg/mb

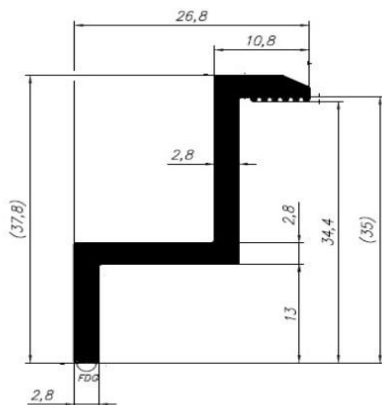
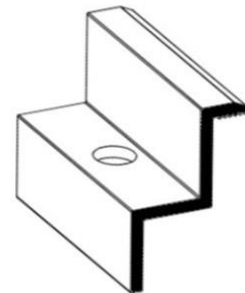

90433
0,446 kg/mb

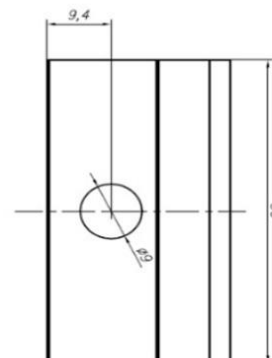

90433 (1)
0,446 kg/mb

